

ASCON spa

ISO 9001
Certified

ASCON spa
20021 Bollate
(Milano) Italy
via Falzarego, 9/11
Tel. +39 02 333 371
Fax +39 02 350 4243
<http://www.ascon.it>
e-mail sales@ascon.it

**Controller
Indicator
Transmitter**

1/32 DIN - 48 x 24



C1 line

User manual • M.I.U.C1-3/03.01 • Cod. J30-478-1AC1 IE



Controller
Indicator
Transmitter

$\frac{1}{32}$ DIN - 48 x 24

C1 line

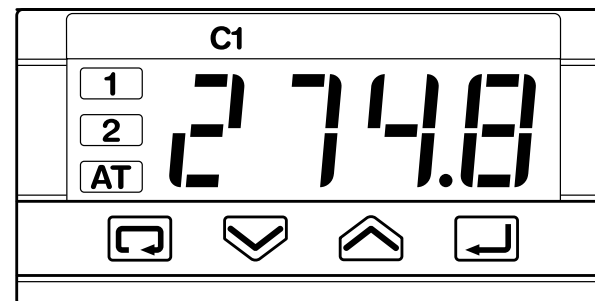



NOTES

ON ELECTRIC SAFETY AND ELECTROMAGNETIC COMPATIBILITY.

Please, read carefully these instructions before proceeding with the installation of the controller.

Class II instrument, real panel mounting.

This controller has been designed with compliance to:

Regulations on electrical apparatus (appliance, systems and installations) according to the European Community directive 73/23/EEC amended by the European Community directive 93/68/EEC and the Regulations on the essential protection requirements in electrical apparatus EN61010-1 : 93 + A2:95.

Regulations on Electromagnetic Compatibility according to the European Community directive n089/336/EEC, amended by the European Community directive n° 92/31/EEC, 93/68/EEC, 98/13/EEC

and the following regulations:

Regulations on RF emissions

EN61000-6-3 : 2001 residential environments

EN61000-6-4 : 2001 industrial environments

Regulation on RF immunity

EN61000-6-2 : 2001 industrial equipment and system

It is important to understand that it's responsibility of the installer to ensure the compliance of the regulations on safety requirements and EMC.

The device has no user serviceable parts and requires special equipment and specialised engineers. Therefore, a repair can be hardly carried on directly by the user. For this purpose, the manufacturer provides technical assistance and the repair service for its Customers.

Please, contact your nearest Agent for further information.

All the information and warnings about safety and electromagnetic compatibility are marked with the  sign, at the side of the note.

TABLE OF CONTENTS

1	INSTALLATION	Page	4
2	ELECTRICAL CONNECTIONS	Page	8
3	PRODUCT CODING	Page	14
4	OPERATIONS	Page	18
5	AUTOMATIC TUNE	Page	28
6	TECHNICAL SPECIFICATIONS	Page	29

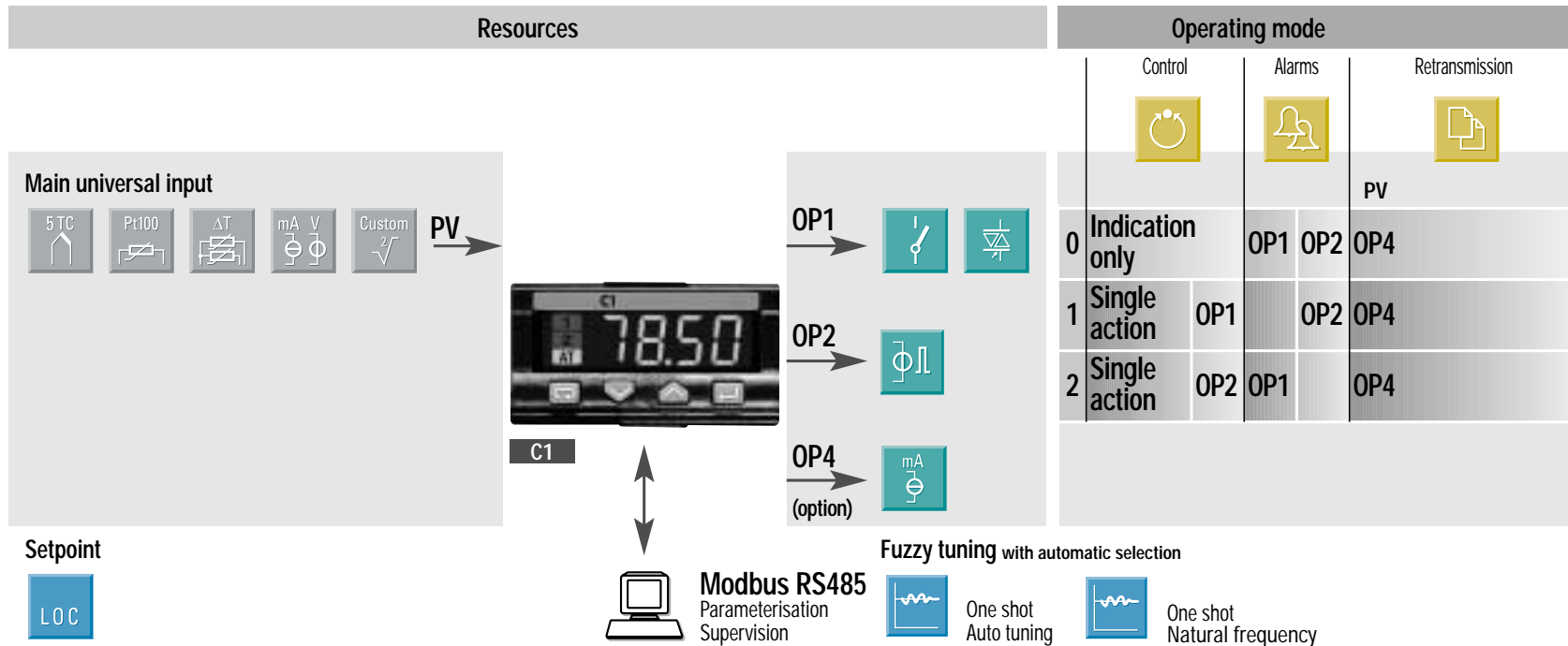

1 INSTALLATION

Installation must only be carried out by qualified personnel.

Before proceeding with the installation of this controller, follow the instructions illustrated in this manual and, particularly the installation precautions marked with the  symbol, related to the European Community directive on electrical protection and electromagnetic compatibility.



To prevent hands or metal touching parts that may be electrically live, the controllers must be installed in an enclosure and/or in a cubicle.

1.1 GENERAL DESCRIPTION

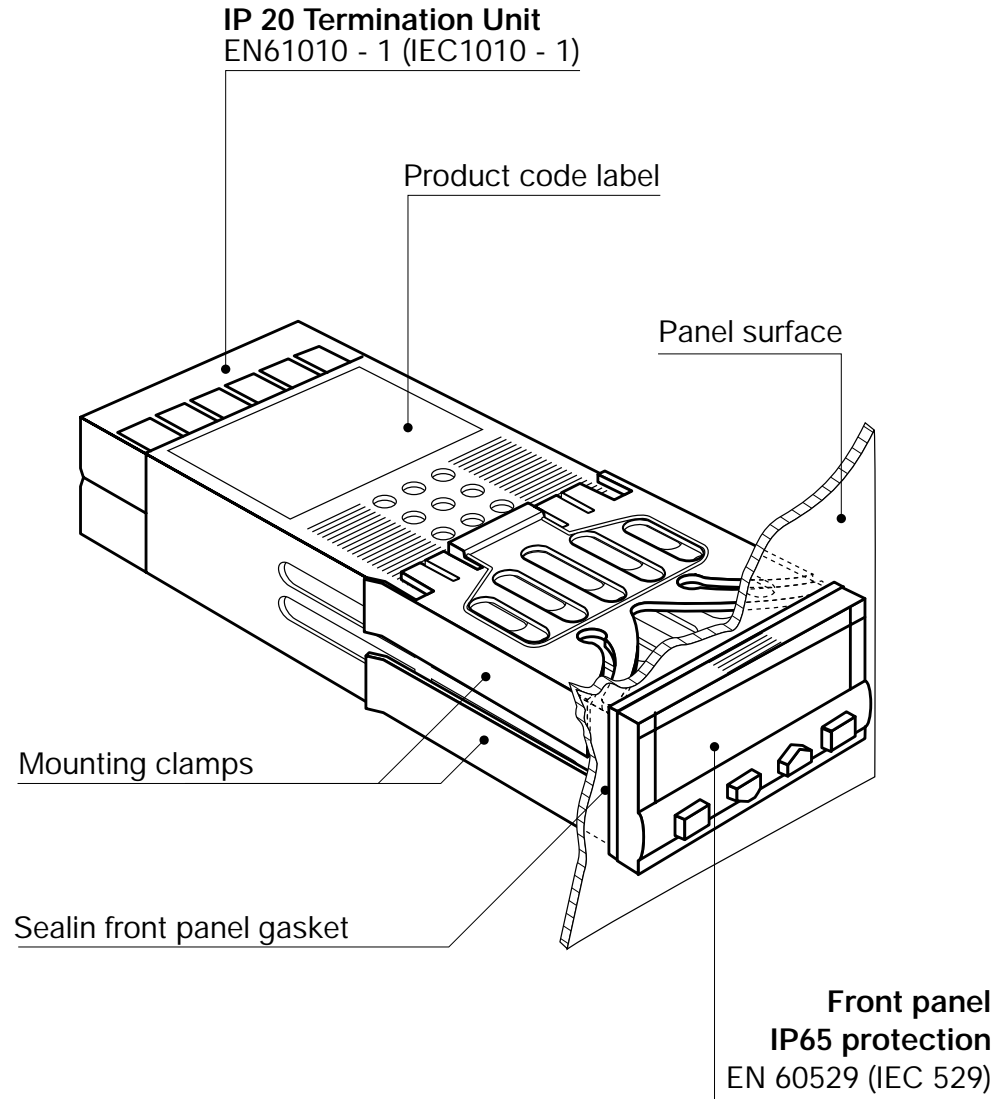

1.2 DIMENSIONAL DETAILS

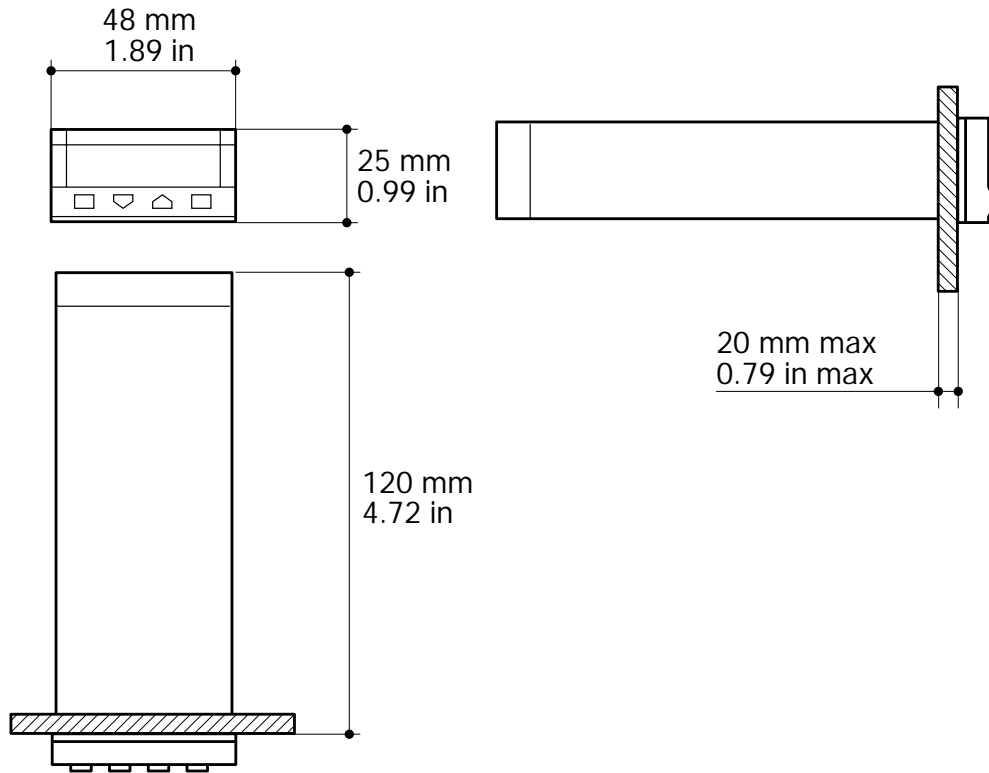



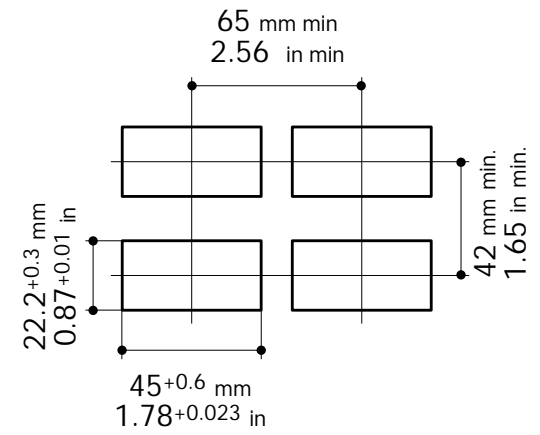





1.3 PANEL CUT-OUT



1.4 ENVIRONMENTAL RATINGS



Operating conditions	
 Altitude up to 2000 m	
 Temperature 0...50°C	
%Rh Relative humidity 5...95 % non-condensing	
Special conditions	Suggestions
 Altitude > 2000 m	Use 24V~ supply version
 Temperature >50°C	Use forced air ventilation
%Rh Humidity > 95 %	Warm up
 Conducting atmosphere	Use filter
Forbidden Conditions 	
 Corrosive atmosphere	
 Explosive atmosphere	

1.5 PANEL MOUNTING [1]

1.5.1 INSERT THE INSTRUMENT

- 1 Prepare panel cut-out
- 2 Check front panel gasket position
- 3 Insert the instrument through the cut-out

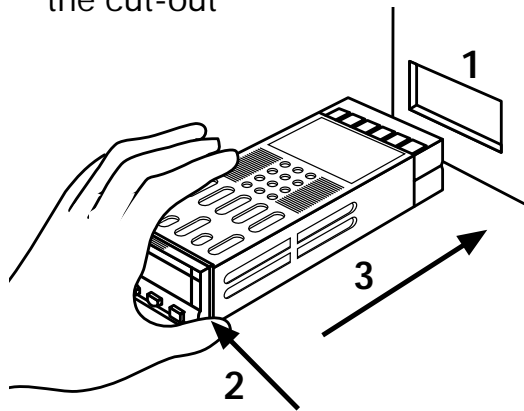

UL note

[1] For Use on a Flat Surface of a Type 2 and Type 3 'raintight' Enclosure.

1.5.2 INSTALLATION SECURING

- 1 Position the mounting clamps
- 2 Push the mounting clamps towards the panel surface to secure the instrument

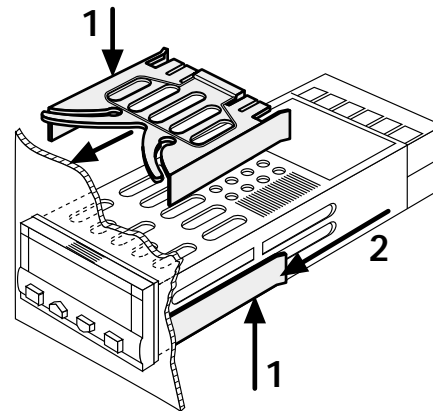

1.5.3 CLAMPS REMOVING

- 1 Insert the screwdriver in the clips of the clamps
- 2 Rotate the screwdriver

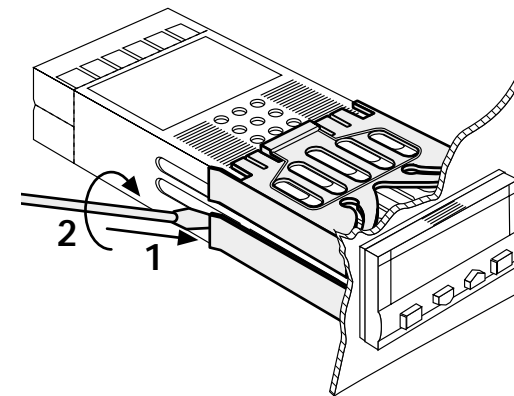

1.5.4 INSTRUMENT UNPLUGGING



- 1 Push and
- 2 pull to remove the instrument

Electrostatic discharges can damage the instrument
Before removing the instrument the operator must discharge himself to ground

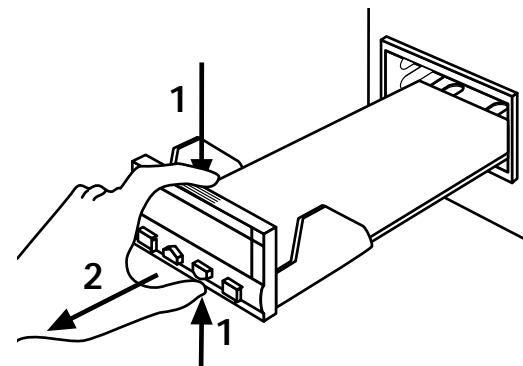

2 ELECTRICAL CONNECTIONS

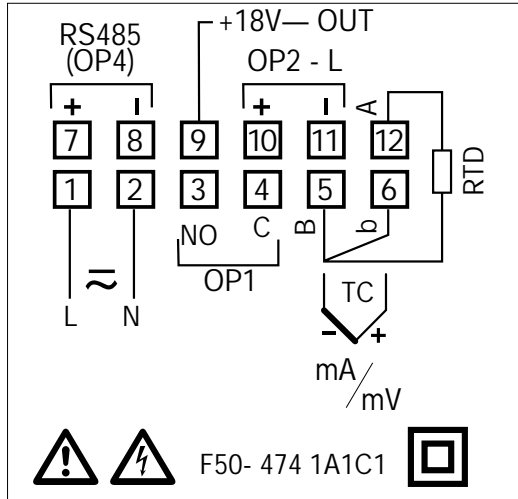

UL note

[1] Use 60/70 °C copper (Cu) conductor only.

12.1 TERMINATION UNIT [1]

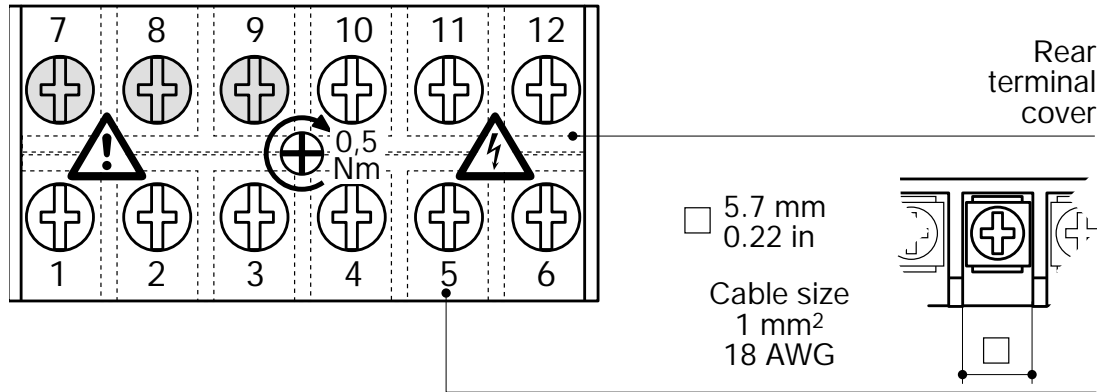

12 screw terminals



Option terminals



Holding screw 0.5 Nm

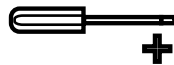

Positive screw driver PH1



Negative screw driver 0,8 x 4 mm

Recommended wire terminal leads

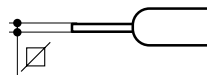

Pin connector \varnothing 1.4 mm - 0.055 in max



Fork-shape AMP 165004 \varnothing 5.5 mm - 0.21 in

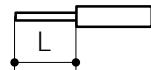

Stripped wire L 5.5 mm - 0.21 in

PRECAUTIONS 

Despite the fact that the instrument has been designed to work in an harsh and noisy environmental (level IV of the industrial standard IEC 801-4), it is strongly recommended to follow the following suggestions.



All the wiring must comply with the local regulations.

The supply wiring should be routed away from the power cables. Avoid to use electromagnetic contactors, power relays and high power motors nearby. Avoid power units nearby, especially if controlled in phase angle

Keep the low level sensor input wires away from the power lines and the output cables.

If this is not achievable, use shielded cables on the sensor input, with the shield connected to earth.

2.2 RECOMMENDED ROUTING OF WIRES 

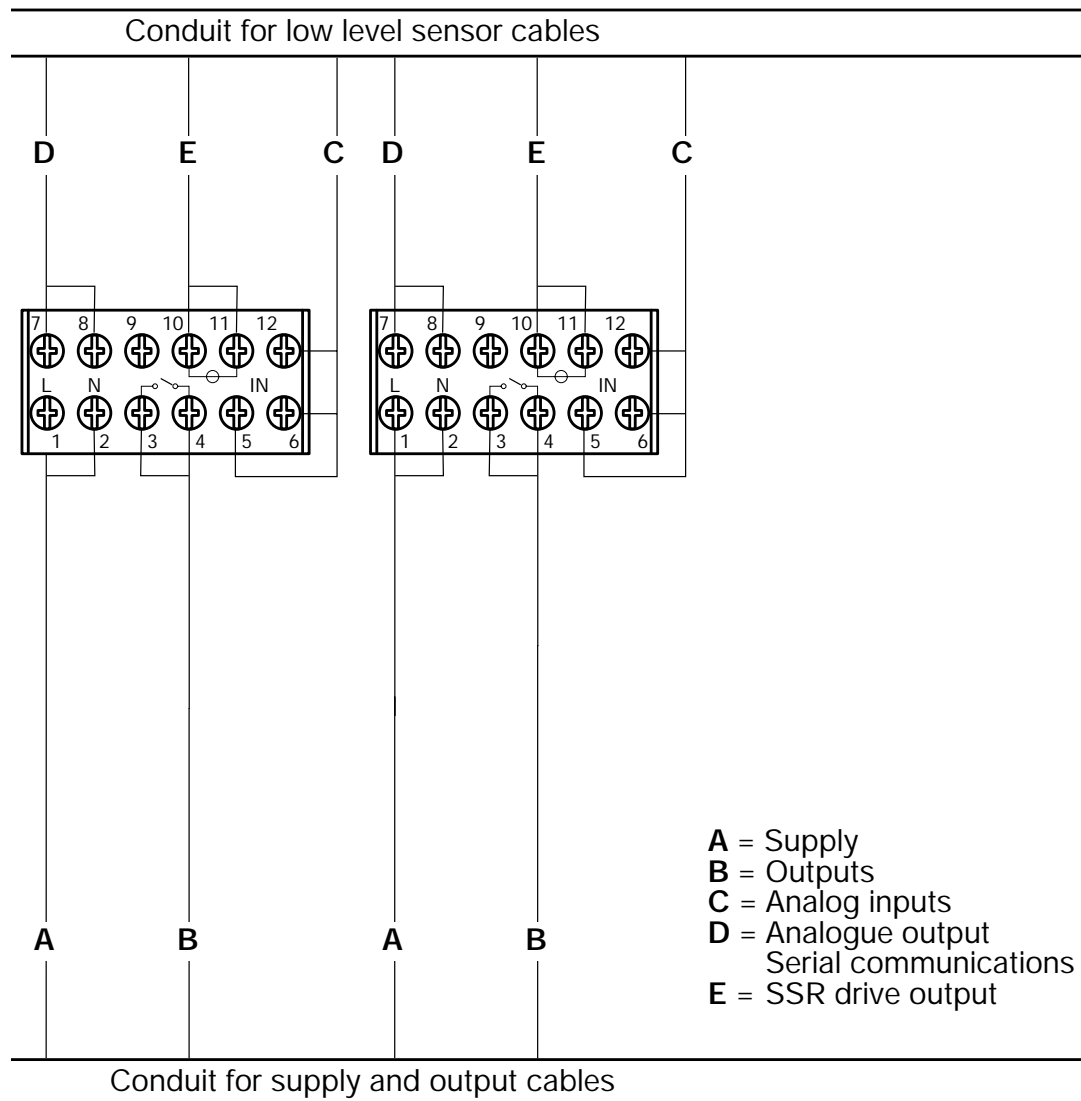

2.3 TYPICAL INSTRUMENT WIRING

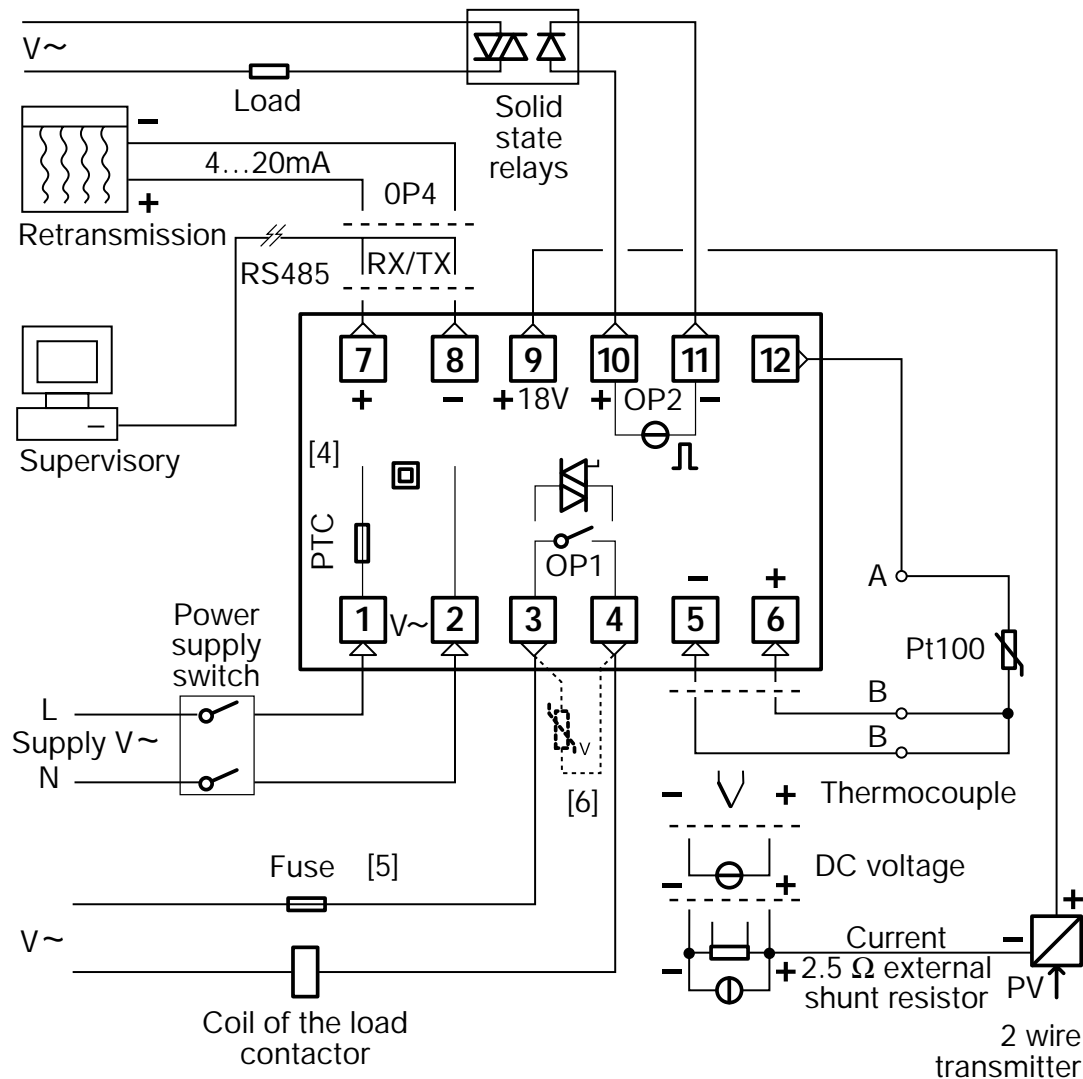

Notes:

- 1] Make sure that the power supply voltage is the same indicated on the instrument.
- 2] Switch on the power supply only after that all the electrical connections have been completed.
- 3] In accordance with the safety regulations, the power supply switch shall bring the identification of the relevant instrument. The power supply switch shall be easily accessible from the operator.
- 4] The instrument is PTC protected. In case of failure it is suggested to return the instrument to the manufacturer for repair.
- 5] To protect the instrument internal circuits use:
 - 2 A ~ T fuses for Relay outputs
 - 1 A ~ T fuses for Triac outputs
- 6] Relay contacts are already protected with varistors.

Only in case of 24 V ~ inductive loads, use model A51-065-30D7 varistors (on request)

2.3.1 POWER SUPPLY 

Switching power supply with multiple isolation and internal PTC

- Standard version:
nominal voltage:
100 - 240V~ (- 15% + 10%)
Frequency 50/60Hz
- Low Voltage version:
Nominal voltage:
24V~ (- 25% + 12%)
Frequency 50/60Hz
or 24V- (- 15% + 25%)
- Power consumption 1.6W max

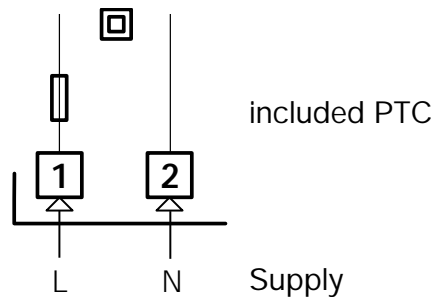

2.3.2 OP1 OUTPUT 

A] Single relay output

- NO contact for resistive load of up to 2A / 250V~ max.
- Fuse 2A~ T (IEC 127)

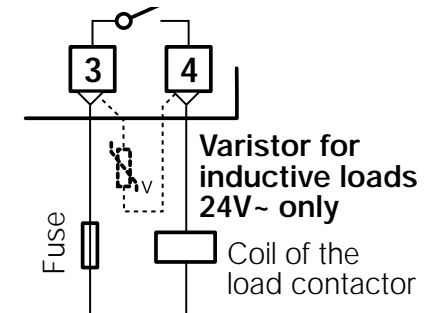

B] Triac Output

- NO contact for resistive load of up to 1A / 250V~ max.
- Fuse 1A~ T (IEC 127)

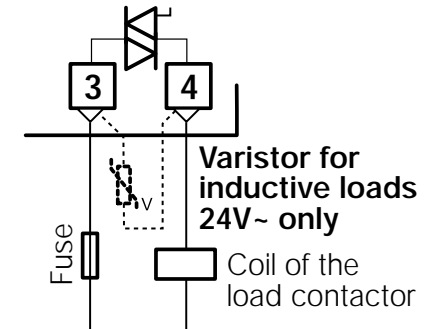

2.3.3 OP2 OUTPUT 

- SSR drive output, not isolated
0...5V-, ±20%, 30mA max

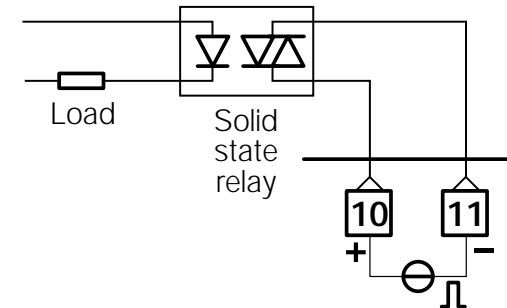

2.3.4 PV CONTROL INPUT



- Connect the wires with the polarity as shown
- Use always compensation cable of the correct type for the thermocouple used
- The shield, if present, must be connected to a proper earth.

For L J K S T thermocouple type

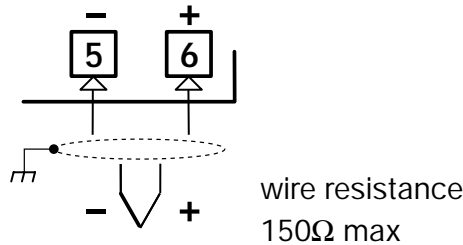

For mA, mV and V

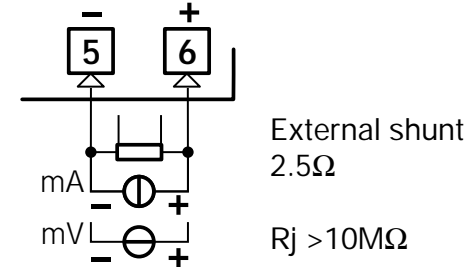

- If a 3 wires system is used, use always cables of the same diameter (1mm² min.) (line 20 Ω/lead maximum resistance)
- When using a 2 wires system, use always cables of the same diameter (1,5mm² min.) and put a jumper between terminals 5 and 6

For PT100 resistance thermometer

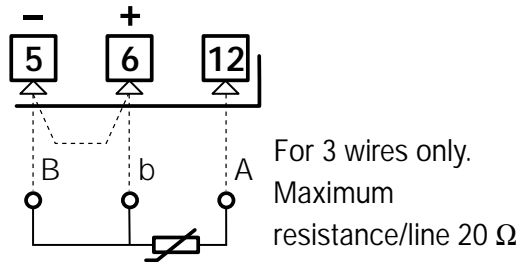

For ΔT (2 x RTD Pt100) Special

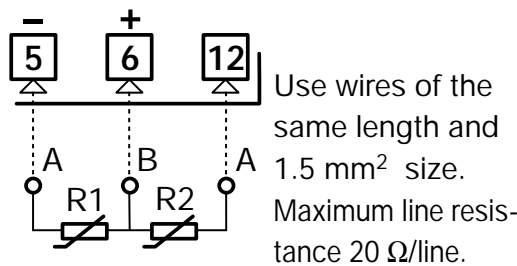

R1 + R2 must be < 320Ω

With 2 wire transducer

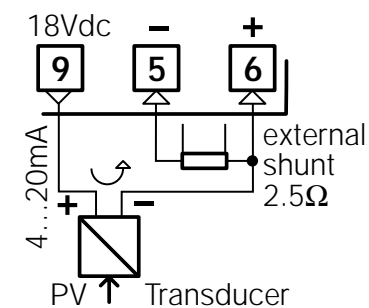

With 3 wire transducer

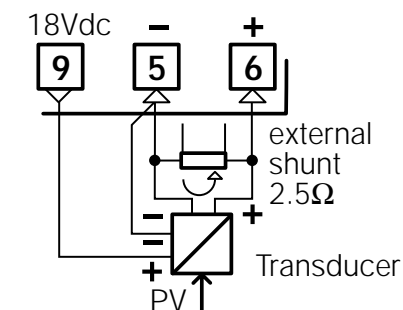

⚠ When the distance between the controller and the sensor is 15 mt. using a cable of 1.5 mm² diameter, produces an error on the measure of 1°C.

2.3.5 OP4 OUTPUT (option)



PV retransmission

- Galvanic isolation
500V \sim /1 min.
- 0/4...20mA, 750 Ω / 15V- max

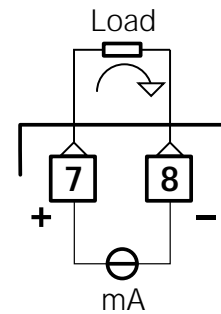

2.3.6 SERIAL COMMUNICATIONS (option)



- Galvanic isolation 500V \sim /1 min
- Compliance to the EIA RS485 standard for Modbus/Jbus

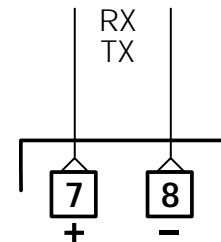

 Please, read:
gammadue[®] and **delta due**[®] con-
 troller series serial communication
 and configuration

3 **PRODUCT CODING**

The complete code is shown on the instrument label. The informations about product coding are accessible from the front panel by mean of a particular procedure described at section 4.2.2 page 19

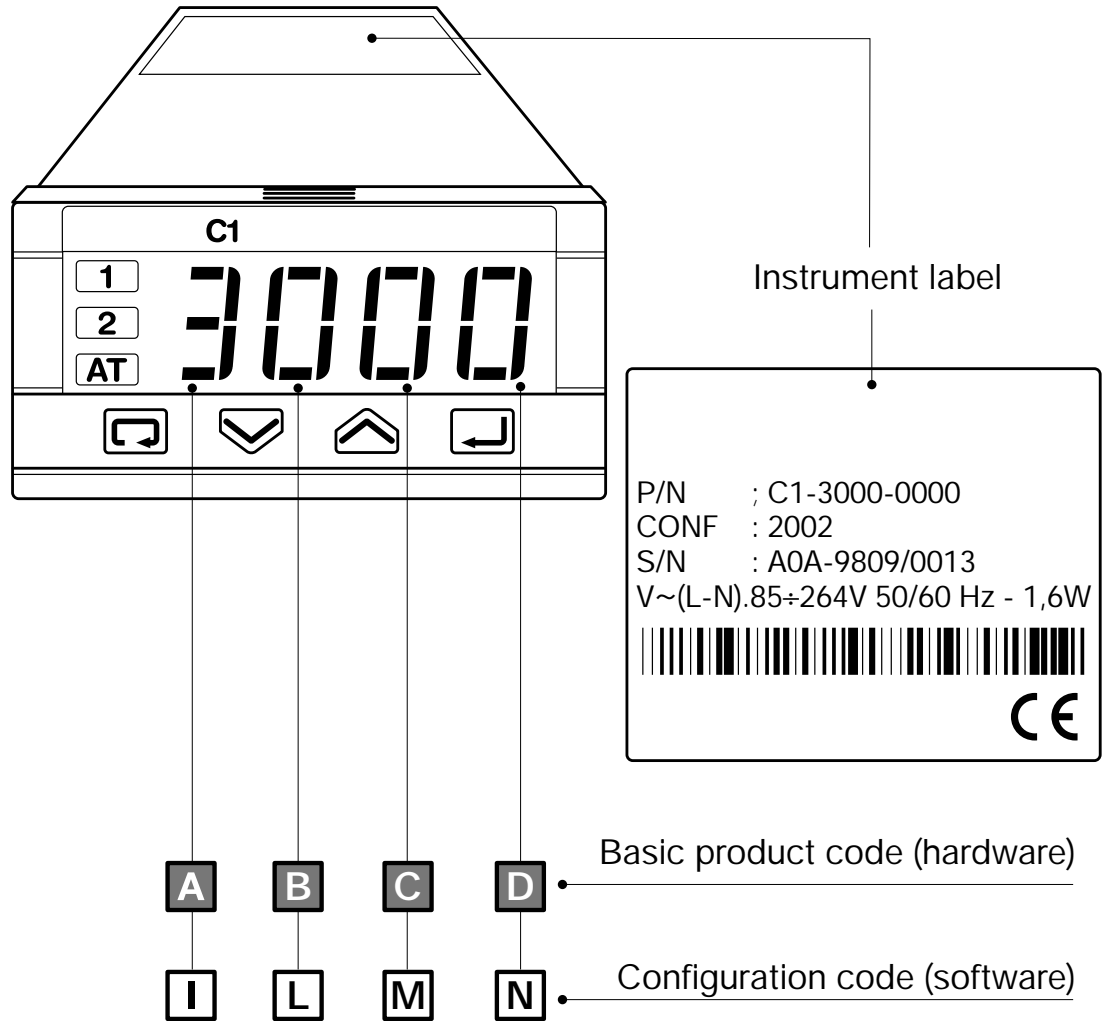

3.1 MODEL CODE

The product code indicate the specific hardware configuration of the instrument, that can be modified by specialized engineers only.

Model: **Line** **C 1** **Basic** **A B C D** - **Accessories** **0 F G 0** / **Configur.** **I L M N**

Line	C 1
-------------	------------

Power supply	A
---------------------	----------

100 - 240V~ (- 15% + 10%)	3
---------------------------	----------

24V~ (- 25% + 12%) or 24V- (- 15% + 25%)	5
--	----------

OP1 Output	B
-------------------	----------

Relay	0
-------	----------

Triac	3
-------	----------

Serial Communications	Options	C	D
------------------------------	----------------	----------	----------

Not fitted	None	0	0
------------	------	----------	----------

	Transmitter Power Supply (P.S.)	0	6
--	---------------------------------	----------	----------

	Transmitter P.S. + Retransmission	0	7
--	-----------------------------------	----------	----------

RS485	None	5	0
-------	------	----------	----------

Modbus/Jbus protocol	Transmitter Power Supply	5	6
----------------------	--------------------------	----------	----------

User manual	F
--------------------	----------

Italian/English (std)	0
-----------------------	----------

French/English	1
----------------	----------

German/English	2
----------------	----------

Spanish/English	3
-----------------	----------

Front panel colour	G
---------------------------	----------

Dark (std)	0
------------	----------

Beige	1
-------	----------

3.2 CONFIGURATION CODING

The configuration code consists of 4 digits that identify the operating characteristic of the controller, as chosen by the user.

Section 4.5 at pag. 26 reports the instructions how to set a new configuration code.

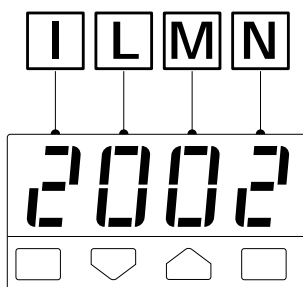

The configuration code can be displayed on the front panel, following the instructions at pag 19 section 4.2.2.

Input type and range			I
TR Pt100 IEC751	-99.9...300.0 °C	-99.9...572.9 °F	0
TR Pt100 IEC751	-200...600 °C	-328...1112 °F	1
TC L Fe-Const DIN43710	0...600 °C	32...1112 °F	2
TC J Fe-Cu45% Ni IEC584	0...600 °C	32...1112 °F	3
TC T Cu-CuNi	-200 ...400 °C	-328...752 °F	4
TC K Cromel -Alumel IEC584	0...1200 °C	32...2192 °F	5
TC S Pt10%Rh-Pt IEC584	0...1600 °C	32...2912 °F	6
DC input 0...50 mV, linear	engineering units		7
DC input 10...50 mV, linear	engineering units		8
Custom input and range			9

Control mode	Output configuration	L
P.I.D.	Control OP1 / alarm AL2 on OP2	0
	Control OP2 / alarm AL2 on OP1	1
On - Off	Control OP1 / alarm AL2 on OP2	2
	Control OP2 / alarm AL2 on OP1	3
2 alarms indicator	Alarm AL1 on OP1/ alarm AL2 on OP2	4
	Alarm AL1 on OP2/ alarm AL2 on OP1	5

Type of control and safety		M
Reverse (AL1 active low)	Safety 0%	0
Direct (AL1 active high)	Safety 0%	1
Reverse (AL1 active low)	Safety 100%	2
Direct (AL1 active high)	Safety 100%	3



If, when the controller is powered up for the first time, the display shows the following message

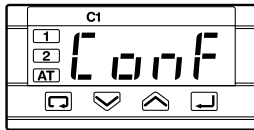

it means that the controller has not been configured yet.

The controller remains in stand-by until the configuration code is set correctly (see chapter 4.6 pag 26).

Alarm 2 type and function		N
Not active		0
Sensor break alarm		1
Absolute	active high	2
	active low	3
Deviation [1]	active high	4
	active low	5
Deviation band [1]	active out (of the band)	6
	active in (the band)	7

Note

[1] Choice not available when the controller has been configured as 2 alarms indicator (L digit assigned to 4 or 5)

4 OPERATIONS

4.1 KEYPAD COMMANDS AND DISPLAY

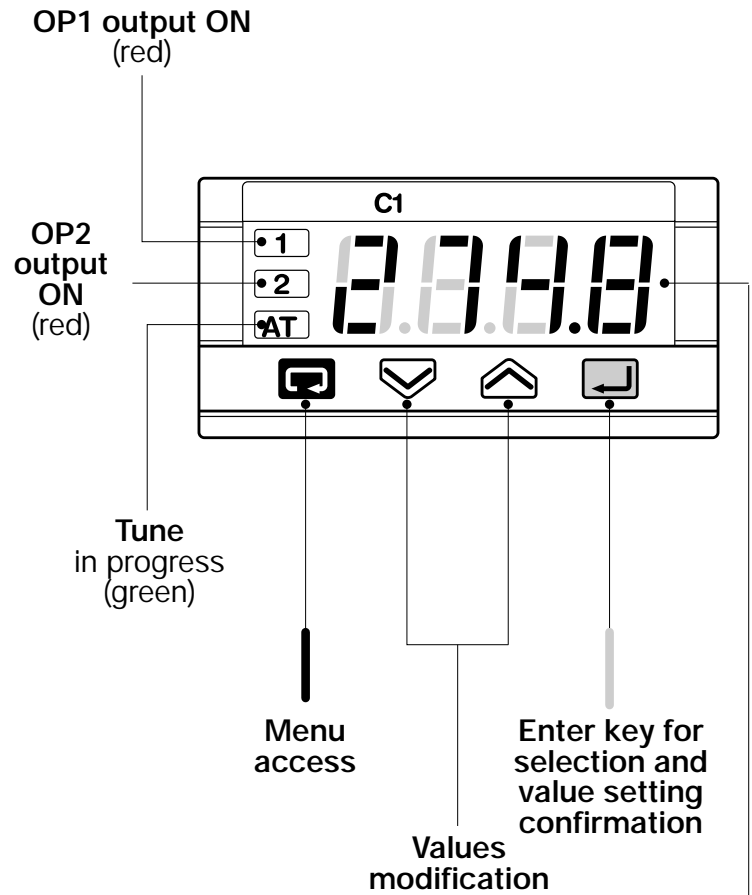

- **PV control input (operator mode)**
(in engineering units)
when the measured value is greater than sensor high range
0000
when the measured value is less than the sensor low range
0000
- **Code and/or value of the Parameter (programming mode)**

4.2 DISPLAY

When the display operation is selected, the controller presents automatically all the most important parameters and configuration information.

During the operation, the parameters values cannot be modified by the user

After 2 sec from the end of the operation, the controller flashes the display and returns to the normal operating conditions.

Note

[1] See table page 27

[2] This display is not presented if the instrument has been configured as an On - Off controller

4.2.1 OF THE PROCESS VARIABLES

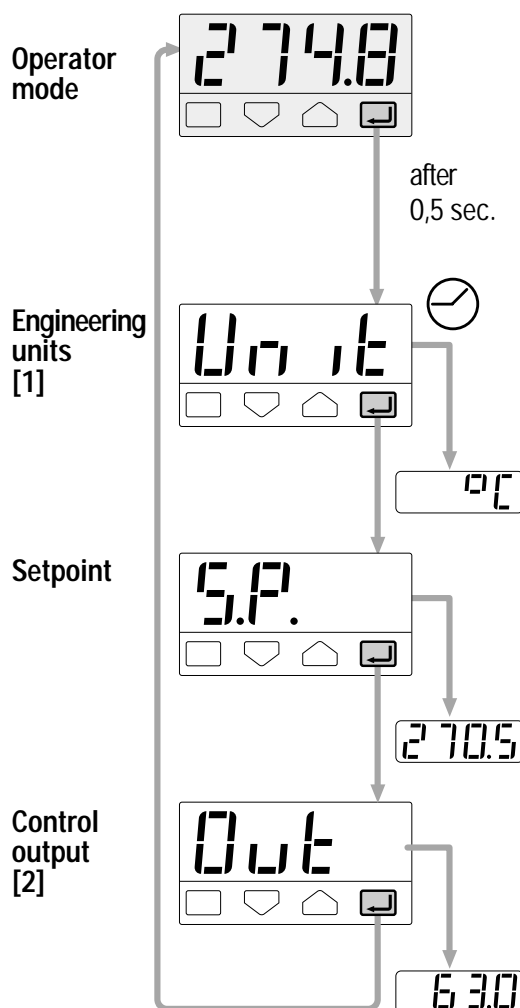

4.2.2 OF THE CONFIGURATION CODES

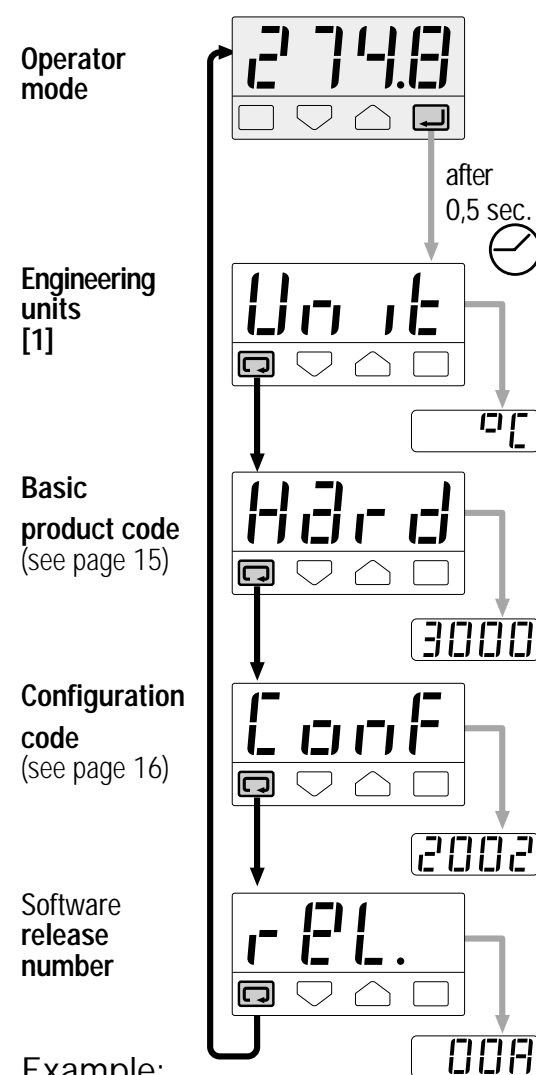





Example:
C1 - 3000 - 2002 / Release 00A

4.3 PARAMETER SETTING

4.3.1 NUMERIC ENTRY

(i.e. the modification of the value of a stored Setpoint from 275.0 to 240.0)

Press  or  momentarily to change the value of 1 unit every push



Continued pressing of  or  changes the value, at rate that doubles every second. Releasing the button the rate of change decreases.

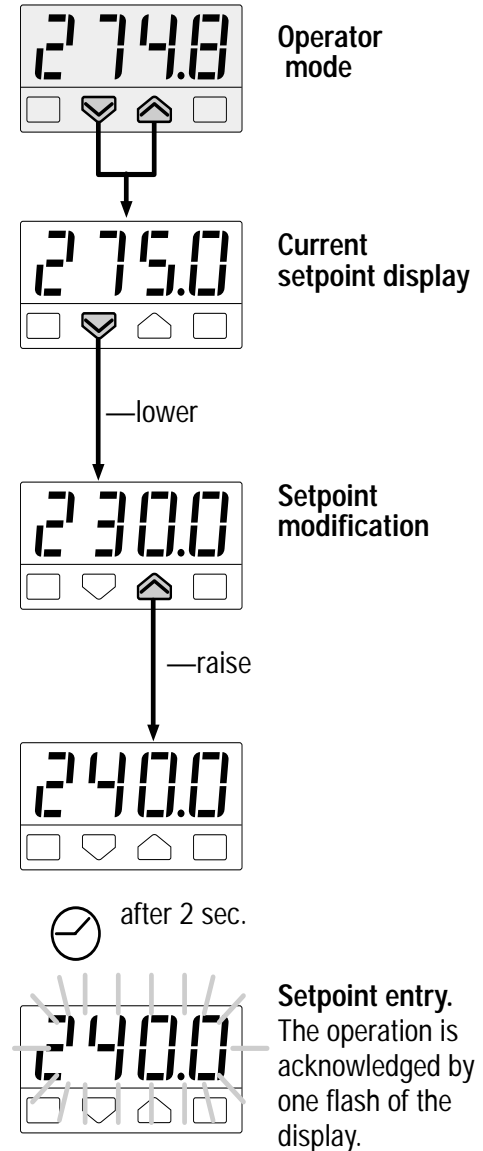

In any case the change of the value stops when it has reached the max/min limit set for the parameter.



4.3.2 MNEMONIC CODES SETTING

(e.g. configuration see pages 26, 27)

Press the  or  to display the next or previous mnemonic for the selected parameter.

Continued pressing of  or  will display further mnemonics at a rate of one mnemonic every 0.5 sec. The mnemonic displayed at the time the next parameter is selected, is the one stored in the parameter.

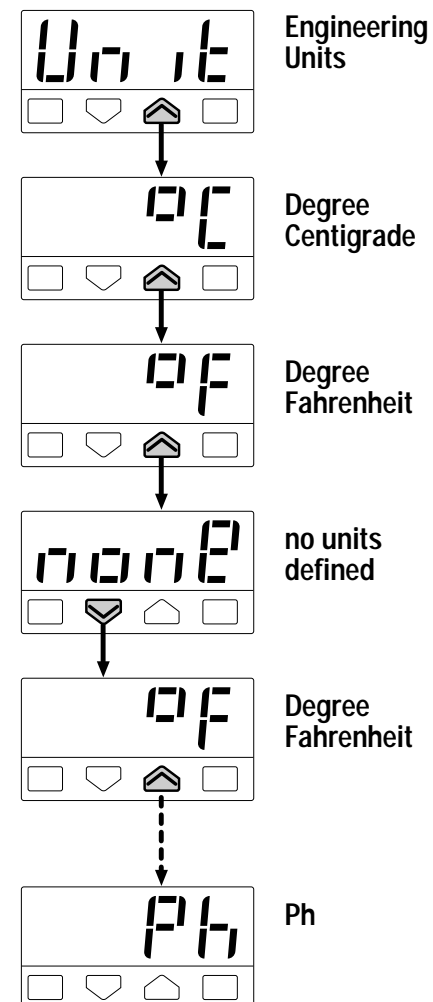

4.4 PARAMETER SETTING

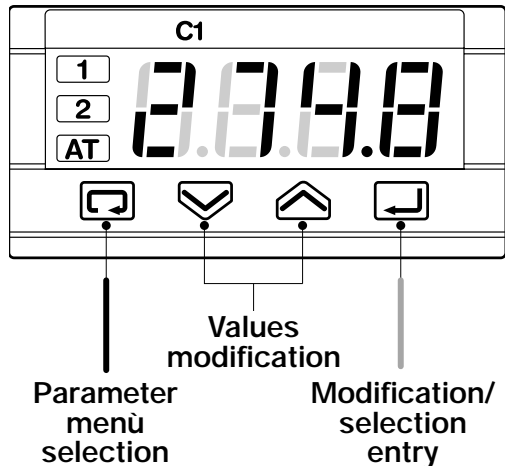

The parameter setting procedure has a timeout. If no keys are pressed for, at least, 30 seconds, the controller switches back, automatically, to the operator mode.

After having selected the parameter or the code, press and to display or modify the value (see pag. 20) The value is entered when the next parameter is selected, by pressing the key.

Pressing the key, the next group of parameters is presented on the display.

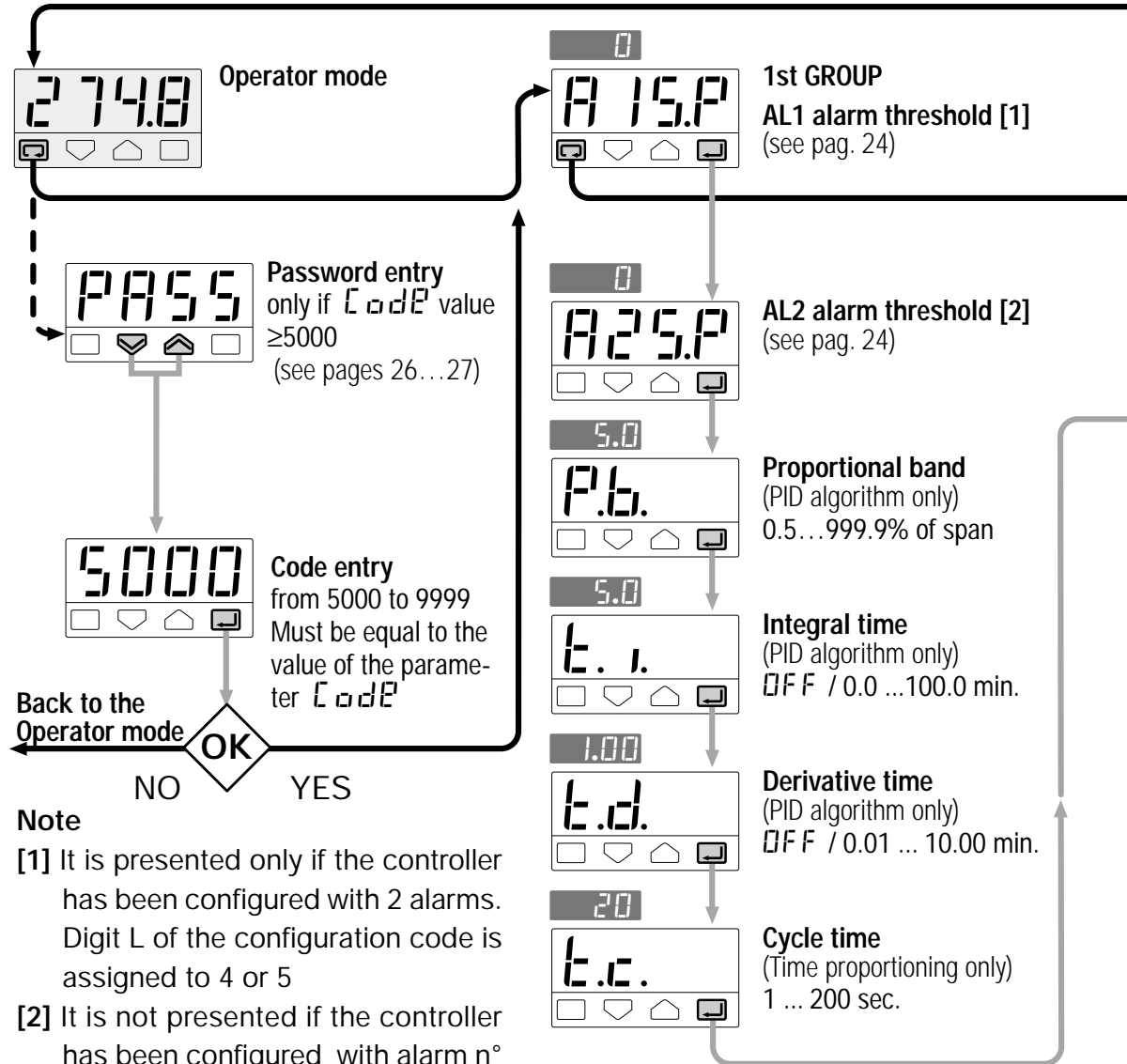

- Note**
- [1] It is presented only if the controller has been configured with 2 alarms. Digit L of the configuration code is assigned to 4 or 5
 - [2] It is not presented if the controller has been configured with alarm n° 2 not active or of sensor break type. Digit N of the configuration code is assigned to 0 or 1.

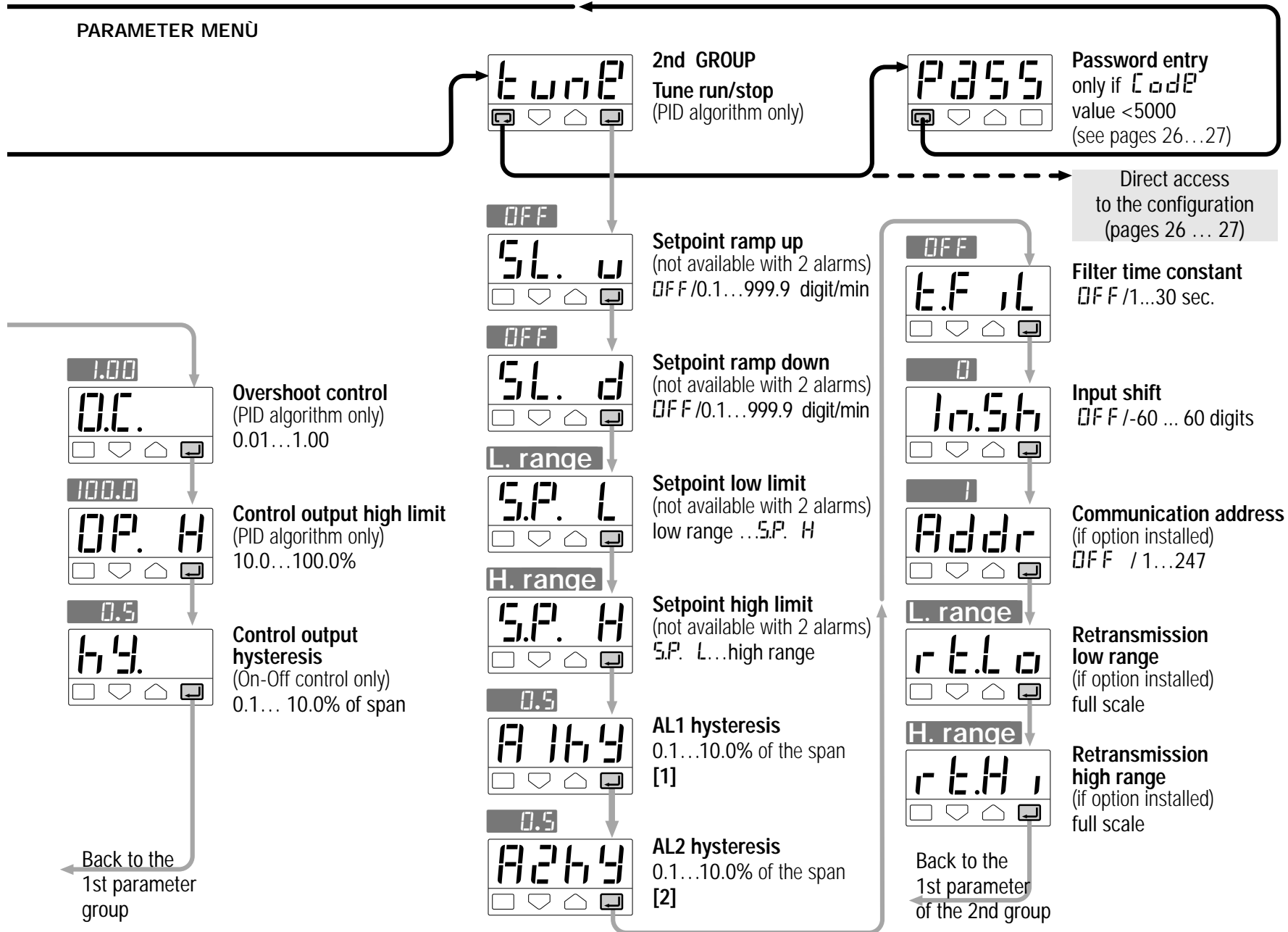

4.5 PARAMETER

1st GROUP

The controller parameters have been organized in group, according to their functionality area.

A15.P AL1 alarm threshold

The threshold is presented only if the controller have been configured with 2 alarms. (Digit L of the configuration code assigned to 4 or 5)

A25.P AL2 alarm threshold

The alarm occurrences handle the OP1 and OP2 outputs, in different ways, according to the configured types of alarms, as illustrated.

P.b. Proportional band

This parameter specifies the proportional band coefficient that multiplies the error (SP - PV)

I. I. Integral time

It is the integral time value, that

Sensor break or input disconnection

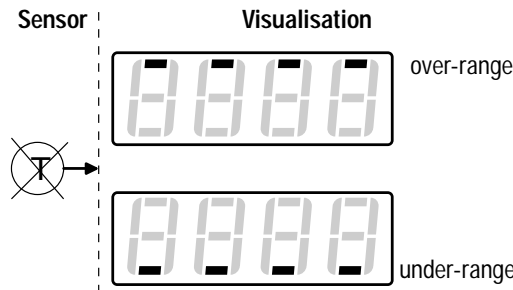

Absolute alarm (full scale)

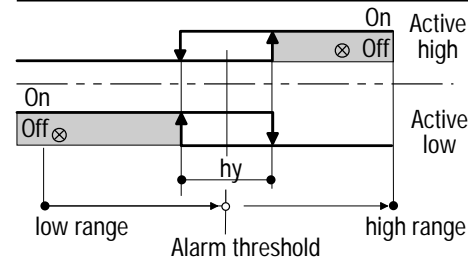

Deviation alarm

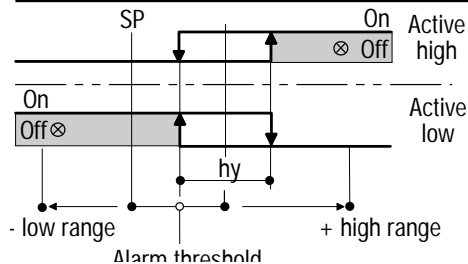

Band alarm

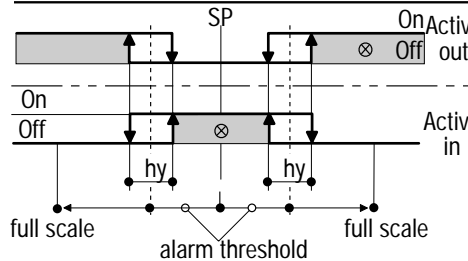

specifies the time required by the integral term to generate an output equivalent to the proportional term. When **FFF** the integral term is not included in the control algorithm.

I.d. Derivative time

It is the derivative term coefficient that specifies the time required by the proportional term P to reach the level of D. When **FFF** the derivative term is not included in the control algorithm.

I.c. Control output cycle time

It's the cycle time of the time proportioning control output. The PID control output is provided through the pulse width modulation of the digital waveform.

O.C. Overshoot control

This parameter specifies the span of action of the overshoot control. Setting lower values (0.99 → 0.01) the overshoot generated by a Setpoint change is reduced. The overshoot control doesn't affect the

effectiveness of the PID algorithm. Setting 1, the overshoot control is disabled.

OP.H Control output high limit

It specifies the maximum value the control output can be set

HY. Control output hysteresis

Hysteresis of the threshold

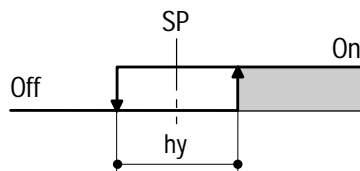

Control output hysteresis span, set in % of the full scale.

2nd GROUP

SL.u Setpoint ramp up

SL.d Setpoint ramp down

This parameter specifies the maximum rate of change of the Setpoint in digit/min. When the parameter is $\square\square\square$, this function is disabled.

SP.L Setpoint low limit

Low limit of the setpoint value. When the parameter is $\square\square\square$, this function is disabled.

SP.H Setpoint high limit

High limit of the setpoint value. When the parameter is $\square\square\square$, this function is disabled.

A1HY AL1 alarm hysteresis

A2HY AL2 alarm hysteresis

Hysteresis of the threshold of both the alarms, that activate OP1 and OP2 control output. It is specified as a % of the full scale.

EF.tl Input filter time constant

Time constant, in seconds, of the RC input filter applied to the PV input. When this parameter is set to $\square\square\square$ the filter is bypassed.

Filter response

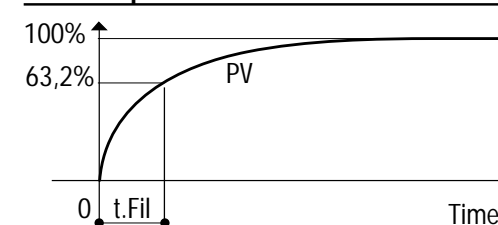

IN.SH Input shift

This value is added to the measured PV input value. Its effect is to shift the whole PV scale of up to ± 60 digits.

Addr Controller address

the address range is from 1 to 247 and must be unique for each controller on the communication bus to the supervisor. When set to $\square\square\square$ the controller is not communicating

rt.Lo Retransmission low range

rt.H Retransmission high range

These parameters define the range of the OP4 retransmission output. Example: 4..20 mA output corresponding to 20...120°C.

4.6 CONFIGURATION

The configuration of the controller is specified through a 4 digit code that defines the type of input, of control output and of the alarms. (sect. 3.2 pag16)

Other parameters specify the type of auxiliary functions.

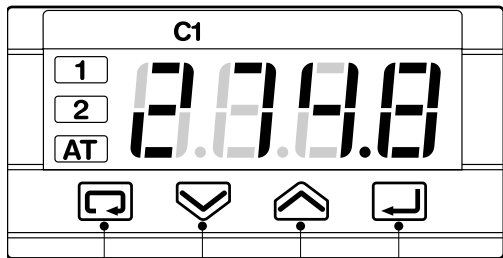

Parameter menu selection (left arrow)
 Values modification (down arrow)
 Modification/selection entry (right arrow)

Press or to display the next parameter or the next code and change its value.

The new value entered is stored into the controller when the next parameter is selected by pressing .

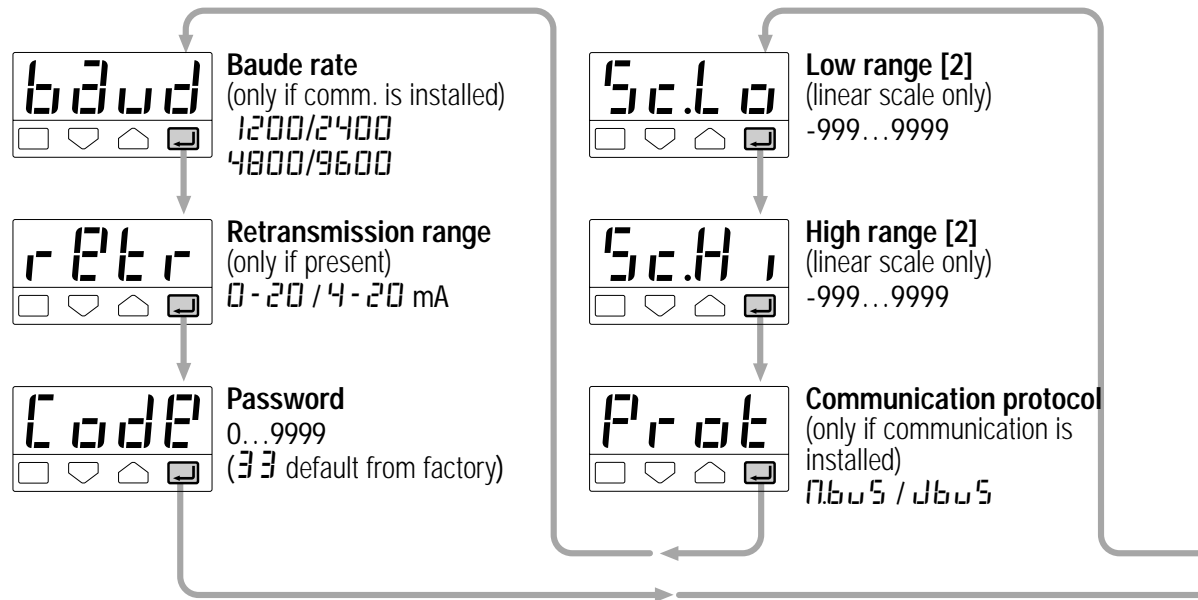
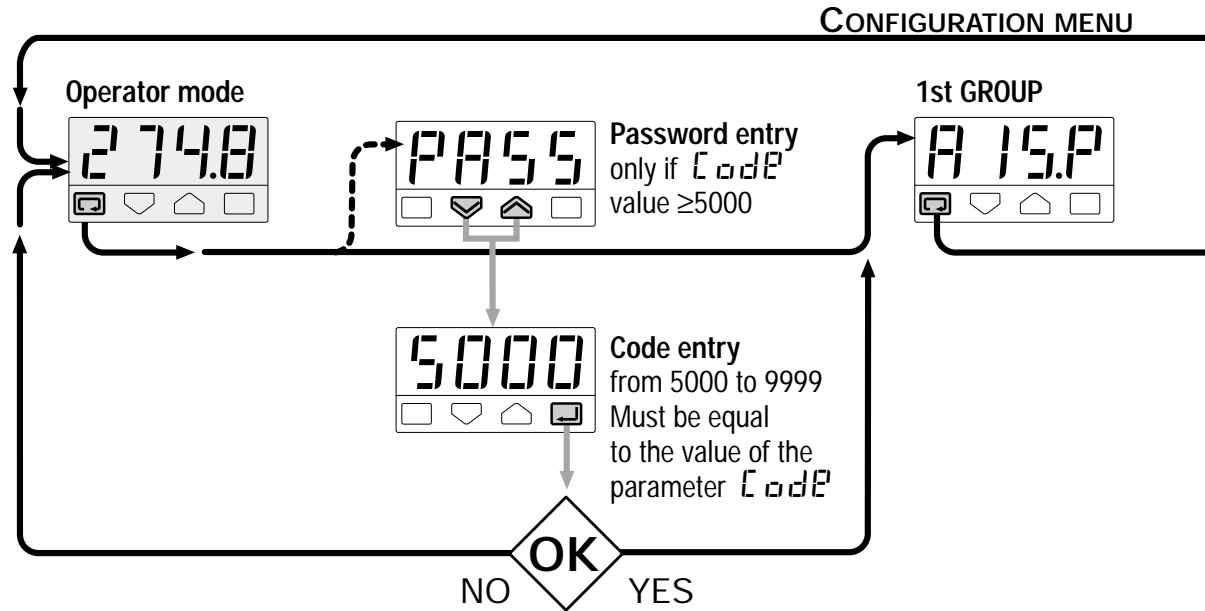

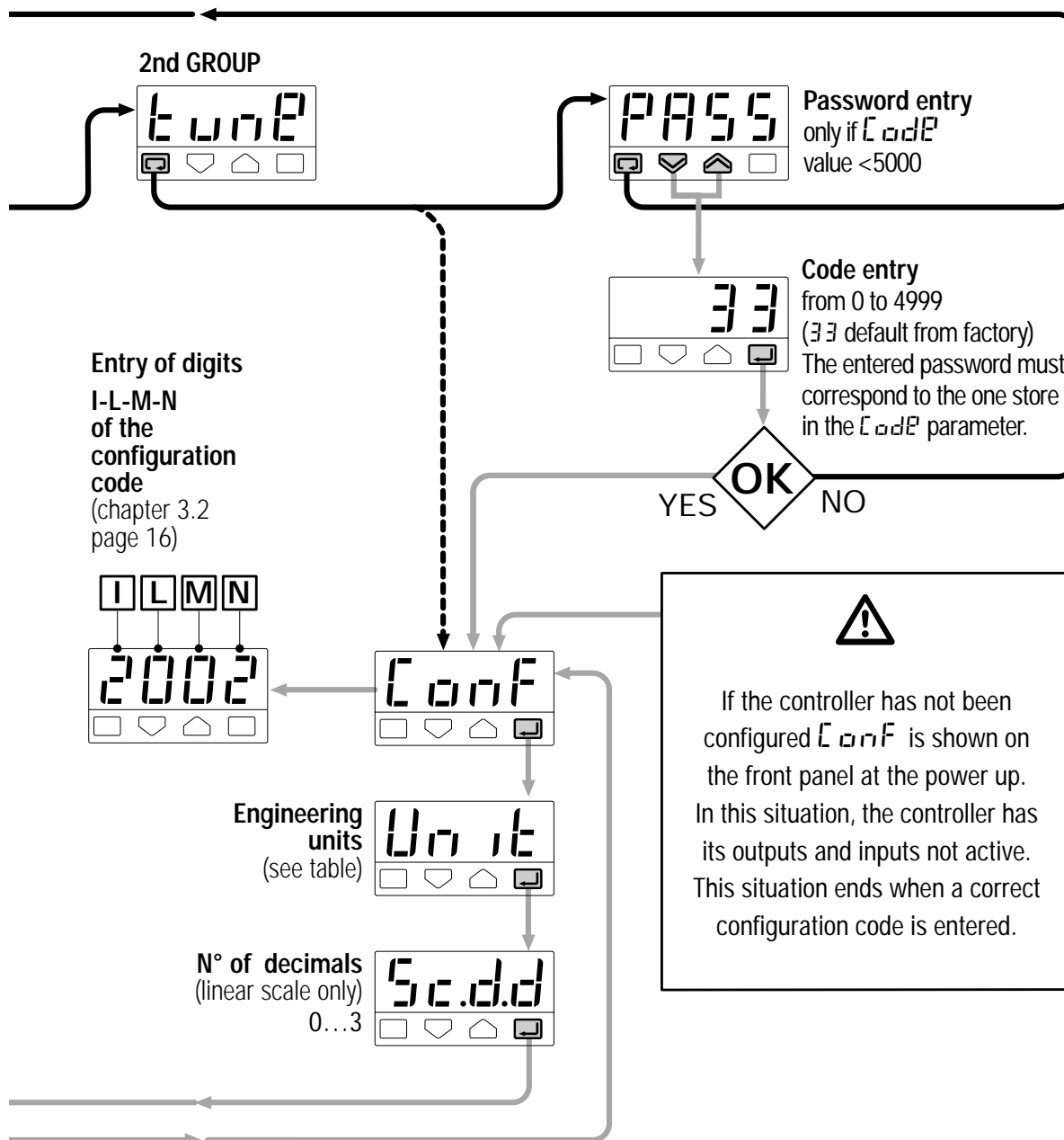

Note

Pressing the the next group of parameters is displayed.

[1] Table of the supported Engineering Units.

Centigrade degrees *	°C
Fahrenheit degrees *	°F
none	none
mV	mV
Volt	V
mA	mA
Ampere	A
Bar	bar
PSI	PSI
Rh	rh
pH	pH

* For inputs from thermocouple or resistance thermometer, the choice is between °C and °F only.

[2] Range of min 100 digits.

5 ■ AUTOMATIC TUNE

Start/stop of the Fuzzy Tuning
The Tuning operation can be started or stopped any time.

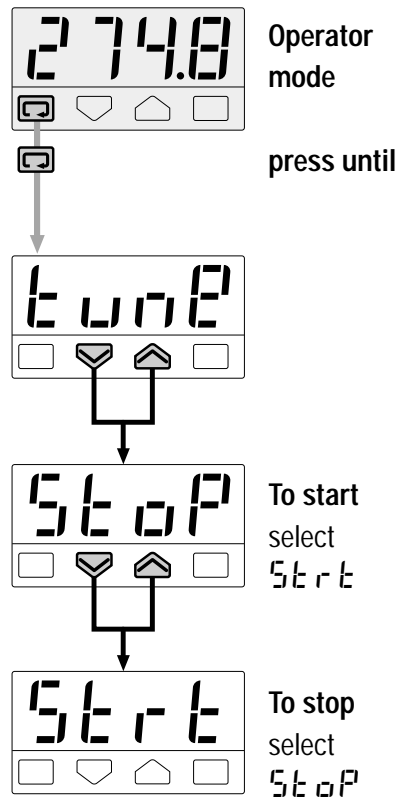

The green led **AT** goes on when the Fuzzy Tuning is in progress. At the end of this operation, the calculated PID terms parameter are stored and used by the control algorithm and the controller goes back to the operator mode. The green led **AT** becomes off.

This function allows the calculation of the optimal PID terms parameters, monitoring the response of the process to disturbances. The controller provides 2 types of "one shot" tuning algorithm, that are selected automatically according to the process condition when the operation is started.

Step response

This type is selected when, at the start of the autotune operation, the PV is far from the Setpoint of more than 5% of the span. This method has the big advantage of fast calculation, with a reasonable accuracy in the term calculation.

Natural frequency

This type is selected when the PV is close to the SP setpoint.

This method has the advantage of a better accuracy in the term calculation with a reasonable speed calculation.

The Fuzzy Tuning determines automatically the best method to use to calculate the PID term, according the process conditions.

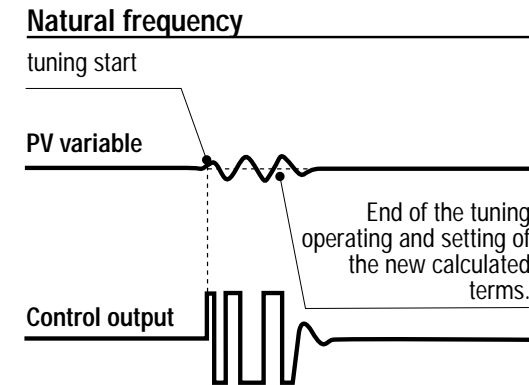
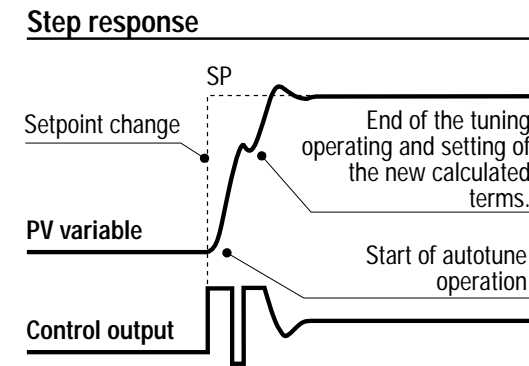

6 TECHNICAL SPECIFICATIONS

Features (at 25°C enviromental temp.)	Description			
Total configurability see par. 3.2 pag. 16 par. 4.6 pag. 26	From keypad or serial communication the user selects: the type of input - the associated functions and the corresponding outputs - the type of control algorithm - the type of output and the safe conditions - the type and functionality of the alarms - the values of all the control parameters.			
PV Input (see pag.12 and pag. 16)	Common characteristics	A/D converter with resolution of 50.000 points Update measurement time: 0.2 seconds Sampling time: 0.5 seconds Input bias: - 60...+ 60 digit Input filter with enable/disable: 1...30 seconds		
	Accuracy	0.25% ± 1 digits for temperature sensors 0.1% ± 1 digits (for mV and mA)	Between 100...240V~ the error is minimal	
	Resistance thermometer	Pt100Ω at 0°C (IEC 751) °C/°Fselectable	2 or 3 wires connection	Max. wire Res.: 20Ω max (3 wires) Sensitivity: 0.35°C/10°C Env. Temp. <0.35°C / 10Ω Wire Res.
	Thermocouple	L,J,T,K,S (IEC 584) °C/°F selectable	Internal cold junction compensation in °C/°F	Max. wire Res.: 150Ω max: <2µV/°C Env. Temp. <5µV / 10Ω Wire Res.
	DC input (current)	4...20mA,0-20mA with external shunt 2.5Ω Rj >10MΩ	Engineering units Conf. decimal point position Init. Sc. -999...9999	Input drift: <0.1% / 20°C Env. temp.
	DC input (voltage)	10...50mV, 0-50mV Rj >10MΩ	Full Sc. -999...9999 (min. range of 100 digits)	

6 - Technical specification

Features (at 25°C environmental temp.)	Description				
Operating mode and Outputs	Indicator with 2 alarms	AL1 alarm		AL2 alarm	
		OP1 - Relay or Triac		OP2 - SSR drive	
	1 PID loop or 1 ON-OFF loop with 1 Alarm	Control output		AL2 alarm	
		OP1 - Relay or Triac		OP2 - SSR drive	
Control Mode	Algorithm		PID with overshoot control or ON OFF		
	Proportional band (P)		0.5...999.9%		
	Integral time (I)		0.1...100.0 min	Off = 0	PID algorithm
	Derivative time (D)		0.01...10.00 min		
	Cycle time		1...200 sec		
	Overshoot control		0.01...1.00		
	High limit		100.0...10.0%		
	Hysteresis		0.1...10.0%		ON-OFF algorithm
OP1 output	SPST Relay N.O., 2A/250V~ for resistive load Triac, 1A/250V~ for resistive load				
OP2 output	SSR drive, not isolated: 5V-, ± 10%, 30mA max				
AL1 alarm (indicator with 2 alarms)	Hysteresis 0.1...10,0% full scale				
	Active high		Absolute threshold, whole range		
	Active low				
AL2 alarm	Hysteresis 0.1...10,0% c.s.				
	Action	Active high	Action type	Deviation threshold	±range
				Band threshold	0...range
		Active low		Absolute threshold	whole range
	Special function	Sensor break			

Features (at 25°C enviromental temp.)	Description	
Setpoint	Ramp up and down	0.1...999.9 digit/min (Off = 0)
	Low limit	From low range to the high limit
	High limit	From low limit to the high range
OP4 PV retransmission (option)	Galvanic isolation: 500 V \sim /1 min Resolution 12bit (0.025%) Accuracy: 0.1 %	Current output: 0/4...20mA 750 Ω /15V max
One shot Fuzzy-Tuning with automatic selection	The controller selects automatically the best method according to the process conditions	Step response Natural frequency
Serial comm. (option)	RS485 isolated, Modbus/Jbus protocol, 1200, 2400, 4800, 9600 bit/sec 2 wires	
Auxiliary Supply	+18V- \pm 20%, 30mA max for an external transmitter supply	
Operational safety	Measure input	Detection of out of range, short circuit or sensor break with automatic activation of the safety strategies and alerts on display
	Control output	Safety value: 0...+100%. (user enabled/disabled)
	Parameters	parameter and configuration data are stored in a non volatile memory for an unlimited time
	Access protection	Password to access the configuration and parameters data
General characteristics	Power supply	100 - 240V \sim (- 15% + 10%) 50/60Hz or 24V \sim (- 25% + 12%) 50/60Hz and 24V- (- 15% + 25%) Power consumption 1.6W max
	Electric safety	Compliance to EN61010, installation class 2 (2500V) pollution class 2
	Electromagnetic compatibility	Compliance to the CE standards for industrial system and equipment
	UL and cUL Omologation	File 176452
	Protection EN650529	IP20 termination unit IP65 front panel
	Dimensions	$\frac{1}{32}$ DIN - 48 x 24, depth 120 mm, weight 100 gr. apx.

■ WARRANTY

We warrant that the products will be free from defects in material and workmanship for 3 years from the date of delivery.

The warranty above shall not apply for any failure caused by the use of the product not in line with the instructions reported on this manual.

ASCON'S WORLDWIDE SALES NETWORK

SUBSIDIARY

FRANCE

ASCON FRANCE

Phone 0033 1 64 30 62 62

Fax 0033 1 64 30 84 98

AGENCE SUD-EST

Phone 0033 4 74 27 82 81

Fax 0033 4 74 27 81 71

AGENCE RÉGION-EST

Phone 0033 3 89 76 99 89

Fax 0033 3 89 76 87 03

DISTRIBUTORS

ARGENTINA

MEDITECNA S.R.L.

Phone +5411 4585 7005

Fax +5411 4585 3437

AUSTRALIA

IPA INDUSTRIAL PYROMETER

(AUST) PTY.LTD

Phone +61 8 8352 3688

Fax +61 8 8352 2873

FINLAND & ESTONIA

TIM-TOOL OY

Phone +358 50 501 2000

Fax +358 9 50 55 144

GERMANY

MESA INDUSTRIE ELEKTRONIK GMBH

Phone +49 2365 915 220

Fax +49 2365 915 225

GREECE

CONTROL SYSTEM

Phone +30 23 10 521 055-6

Fax +30 23 10 515 495

BRANCH OFFICE

Phone +30 1 646 6276

Fax +30 1 646 6862

HOLLAND

TEMPCONTROL I.E.P. B.V.

Phone +31 70 347 64 31

Fax +31 70 38 22 55 16

PORTUGAL

REGIQUIPAMENTOS LDA

Phone +351 21 989 0738

Fax +351 21 989 0739

SPAIN

INTERBIL S.L.

Phone +34 94 453 50 78

Fax +34 94 453 51 45

BRANCH OFFICES

Phone +34 93 311 98 11

Fax +34 93 311 93 65

Phone +34 91 656 04 71

Fax +34 91 656 04 71

SWITZERLAND

CONTROLTHERM GMBH

Phone +41 1 954 37 77

Fax +41 1 954 37 78

TURKEY

KONTROL SISTEMLERI LTD

Phone +90 216 527 96 15

Fax +90 216 527 96 20

UNITED KINGDOM

EUKERO CONTROLS LTD

Phone +44 20 8568 4664

Fax +44 20 8568 4115